

PANEL "MDP"											
Ckt	SERVES	Ckt Brkr		CONDUCTORS / CONDUIT	Continuous VA			Non-continuous VA			
		Trip	Poles		Light	Load2	Load3	Recept.	Load2	Load3	Total VA
1	Panel A	200	2	3 # 4/0, # 4G in 2" C.				3,060	36,700	39,760	
2	Panel B	200	2	3 # 3/0, # 6G in 2" C.				3,060	35,900	38,960	
3	Panel C	200	2	3 # 3/0, # 6G in 2" C.				3,780	40,152	43,932	
4	Panel D	200	2	3 # 3/0, # 6G in 2" C.				4,140	37,758	41,898	
5	Panel E	200	2	3 # 3/0, # 6G in 2" C.				2,520	32,428	34,948	
6	Panel F	200	2	3 # 3/0, # 6G in 2" C.				2,160	33,228	35,388	
7	Panel G	200	2	3 # 3/0, # 6G in 2" C.				2,160	33,228	35,388	
8	Panel H	200	2	3 # 4/0, # 4G in 2" C.				2,520	35,828	38,348	
9	Panel I	200	2	3 # 250, # 4G in 2.5" C.				3,240	37,300	40,540	
10	Panel J	200	2	3 # 4/0, # 4G in 2" C.				2,880	38,800	41,680	
11	Panel K	200	2	3 # 3/0, # 6G in 2" C.				2,700	34,120	36,820	
12	Panel L	200	2	3 # 4/0, # 4G in 2" C.				2,520	32,448	34,968	
13	Panel M	200	2	3 # 3/0, # 6G in 2" C.				2,520	33,228	35,748	
14	Space Only		3								
15	Space Only (Future Ret.)		3								
16	Space Only (Future Ret.)		3								
17	Space Only (Future Ret.)		3								
18	Space Only		3								
SERVICE: 120/208 volt, 3 phase, 4 wire + G											
MAINS: 1200A-3R FUSED SWITCH											
MOUNTING: Floor											
Avail. Fault Current (RMS Sym.) = 55,000											
Notes:											
(1) Copper Bussing											
(2) Hinged Door											
(3) NEMA 3R Enclosure											
					PANEL CONNECTED VA		498,378				
					PANEL DEMAND VA		274,165				
					PANEL CALCULATED VA		498,378				
					PANEL SPARE VA		54,837				
					PANEL DESIGN VA		563,215				
					PANEL CONNECTED AMPS / PHASE		1384				
					PANEL DEMAND AMPS / PHASE		762				
					PANEL DESIGN AMPS / PHASE		1537				

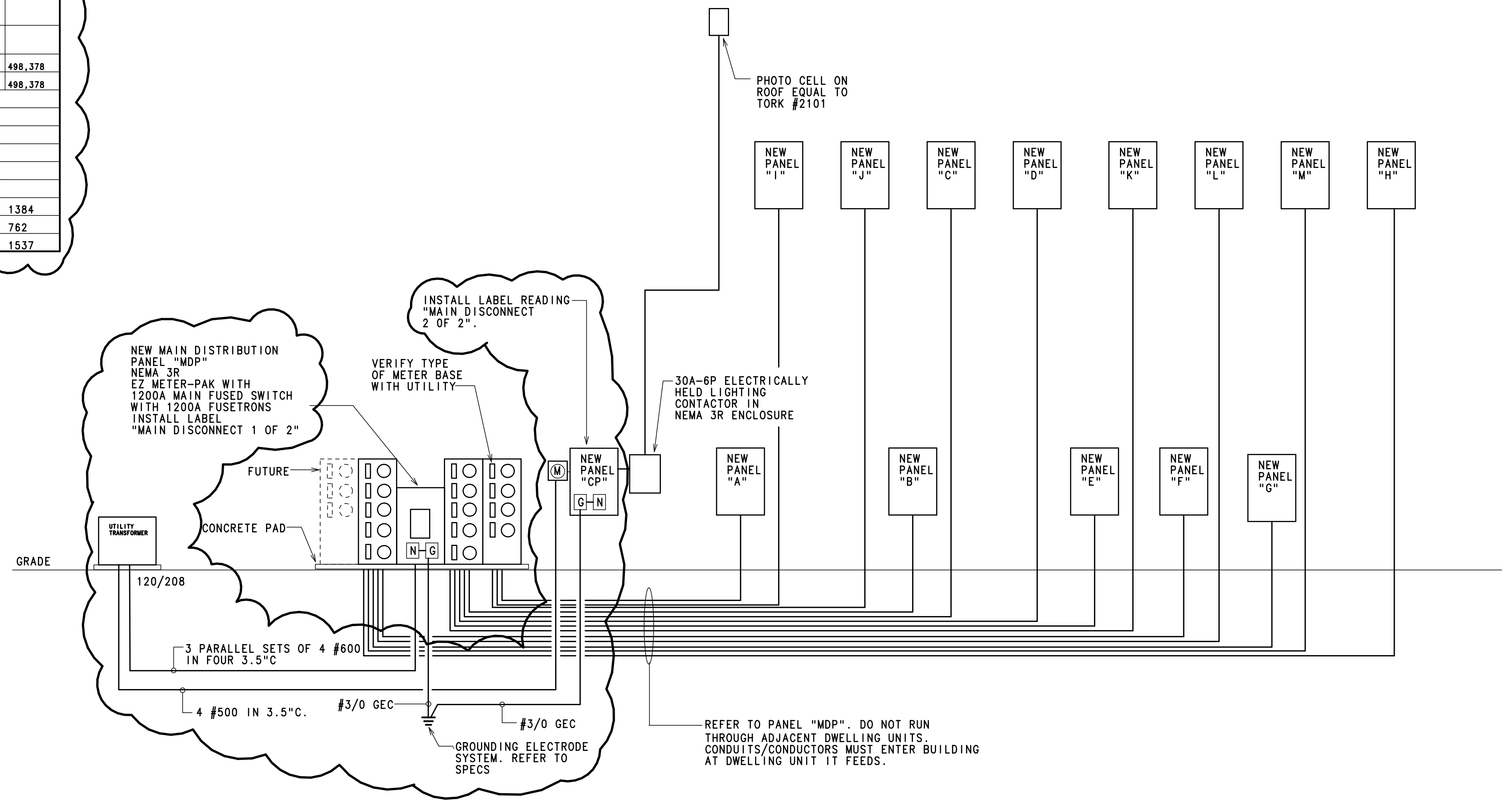

Copyright © 2018. Drawings and specifications are instruments of service and shall remain the property of Gregg Bliss, Architect. They are not to be used on other projects or extensions to this project without the express written consent of Gregg Bliss, Architect. The architect will not be responsible for construction means, methods, techniques, sequences or procedures, or for safety.

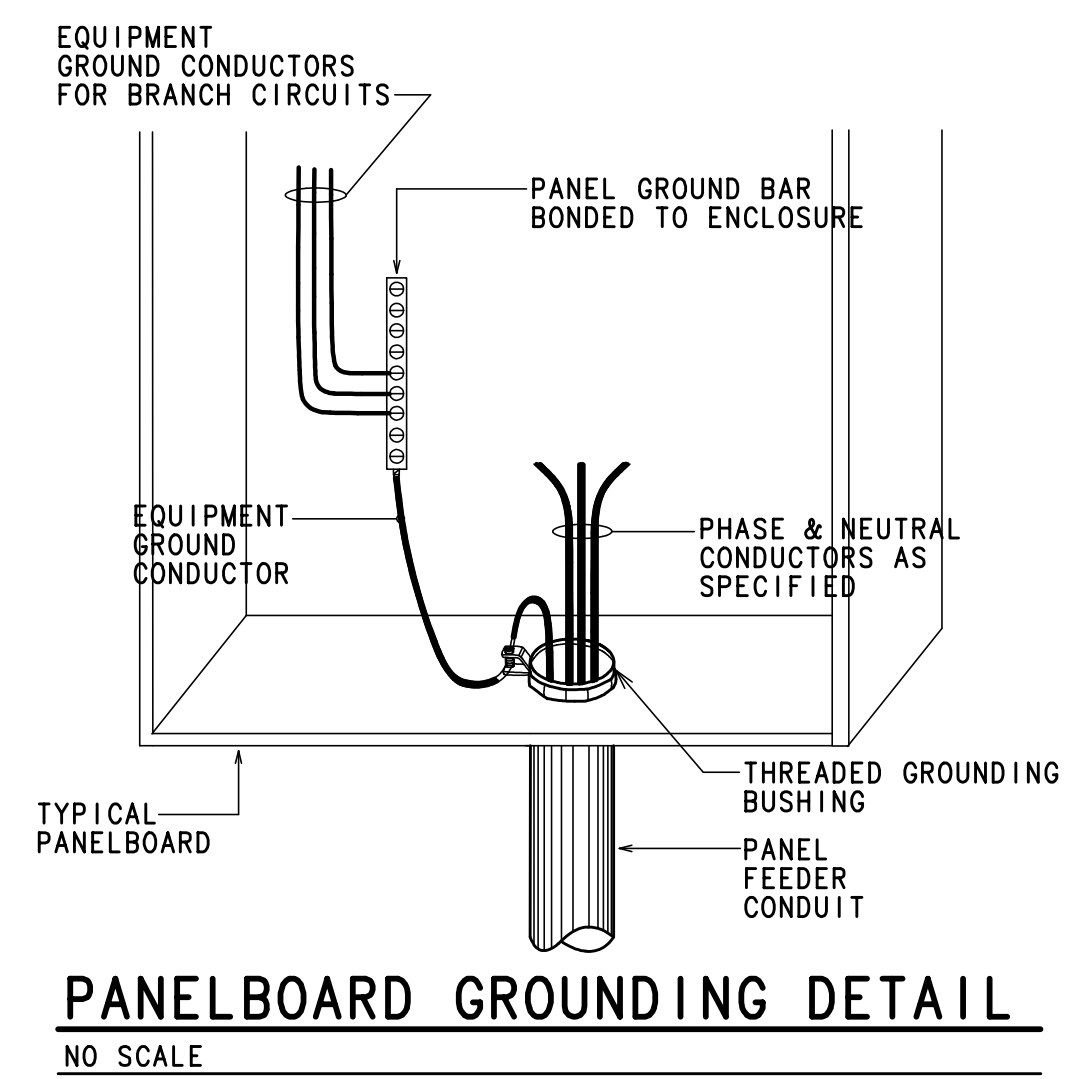
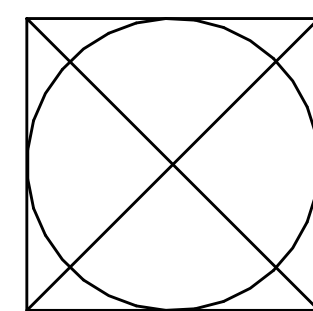

**FANNING, FANNING & ASSOCIATES**  
CONSULTING ENGINEERS  
2855 74th STREET LUBBOCK, TEXAS 79423  
(806) 745-2533

**gregg bliss**  
ARCHITECT

1001 se 3rd ave  
amarillo, texas 79102

(806) 372-2966



renovations to the  
**firestone building**  
amarillo, tx

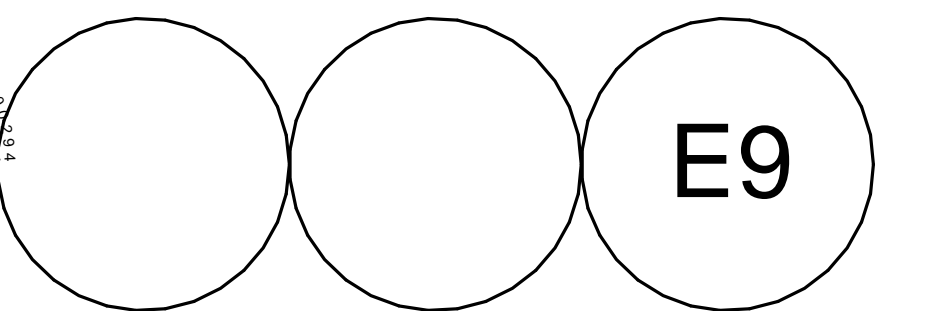
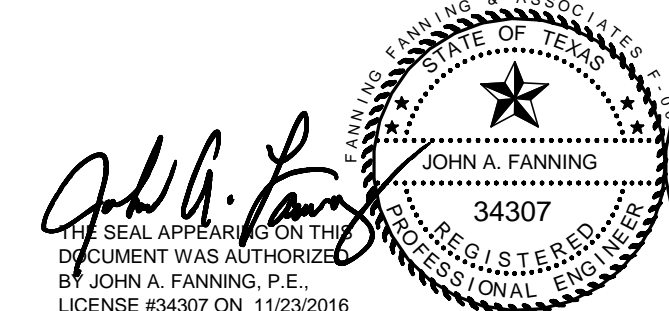
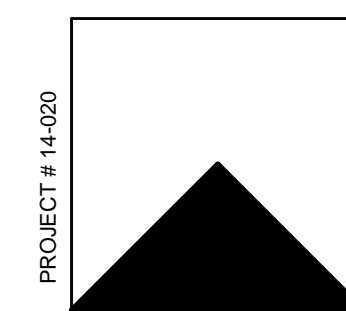

Copyright © 2014. Drawings and specifications are instruments of service and shall remain the property of Gregg Bliss, Architect. They are not to be used on other projects or extensions to this project without the express written consent of Gregg Bliss, Architect. The architect will not be responsible for construction means, methods, techniques, sequences or procedures, or for safety.

PANEL "I" table with columns for CKT, BRKR, WIRE, SERVES, Continuous VA, Non-Cont VA, and WIRE BRKR CKT. Includes notes on copper bussing and hinged door.

PANEL "J" table with columns for CKT, BRKR, WIRE, SERVES, Continuous VA, Non-Cont VA, and WIRE BRKR CKT. Includes notes on copper bussing and hinged door.

PANEL "K" table with columns for CKT, BRKR, WIRE, SERVES, Continuous VA, Non-Cont VA, and WIRE BRKR CKT. Includes notes on copper bussing and hinged door.

PANEL "CP" table with columns for CKT, BRKR, WIRE, SERVES, Continuous VA, Non-Cont VA, and WIRE BRKR CKT. Includes notes on copper bussing and hinged door.

PANEL "L" table with columns for CKT, BRKR, WIRE, SERVES, Continuous VA, Non-Cont VA, and WIRE BRKR CKT. Includes notes on copper bussing and hinged door.

PANEL "M" table with columns for CKT, BRKR, WIRE, SERVES, Continuous VA, Non-Cont VA, and WIRE BRKR CKT. Includes notes on copper bussing and hinged door.

PANEL "CP" continuation table with columns for CKT, BRKR, WIRE, SERVES, Continuous VA, Non-Cont VA, and WIRE BRKR CKT. Includes notes on copper bussing and hinged door.

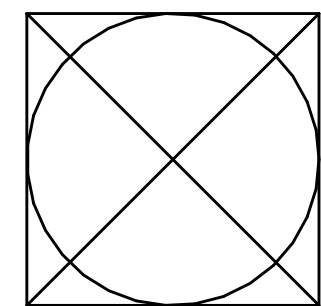

FANNING, FANNING & ASSOCIATES CONSULTING ENGINEERS 2555 74th STREET LUBBOCK, TEXAS 79423 (806) 745-2533

gregg bliss ARCHITECT

1001 se 3rd ave amarillo, texas 79102

(806) 372-2966



renovations to the firestone building amarillo, tx

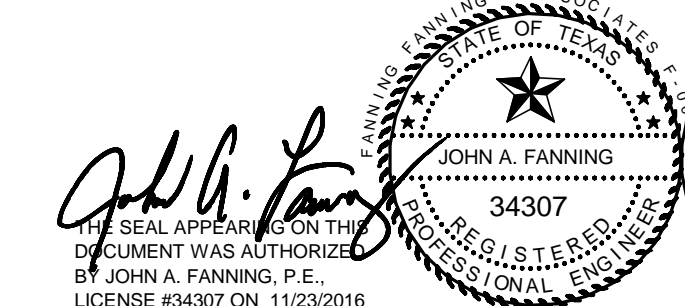
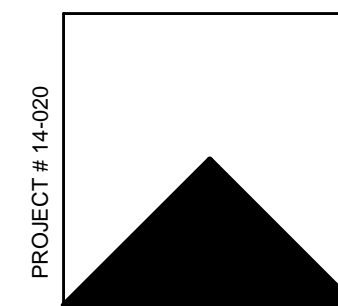

E11